

Control Network Solutions

OPENING NETWORK FRONTIERS

***It's not just about the building's structure,
It's about the substance,
Its impact on the people and the environment it
shares***

MJW 2005

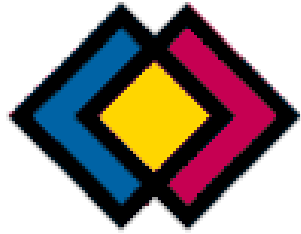

Control Network Solutions

OPENING NETWORK FRONTIERS

About Control Network Solutions Ltd (CNS) –

CNS is a Niagara AX Developer, Tridium and Honeywell Partner. It has a successful track record of creating both client specific and off the shelf solutions to the SMART built environment world and beyond based upon open standards network communication protocols.



About CNS Niagara AX Products

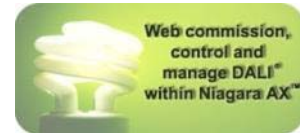







- ◆ Are **vendor independent** – Many device suppliers, many Niagara AX web convergent platform OEM suppliers and 1000's of System Integrators
- ◆ **Seamlessly co-exists with other applications** running on the Niagara AX platform so offers a **High Return on Investment!**
- ◆ **Reduce** commissioning time, errors and risk, no IO mapping/labelling
- ◆ Have **simple** to understand architecture, **low** installed component count, providing **low risk and cost solution**

elitedali Multidrop for Niagara AX®



Entirely Web based Niagara AX® solution for DALI® intelligent lamps -

-  Commissioning
-  Control
-  Maintenance
-  Management
-  Visualisation
-  Analytics

Delivered by organizations whose business depends upon delivering high quality solutions and levels of service.

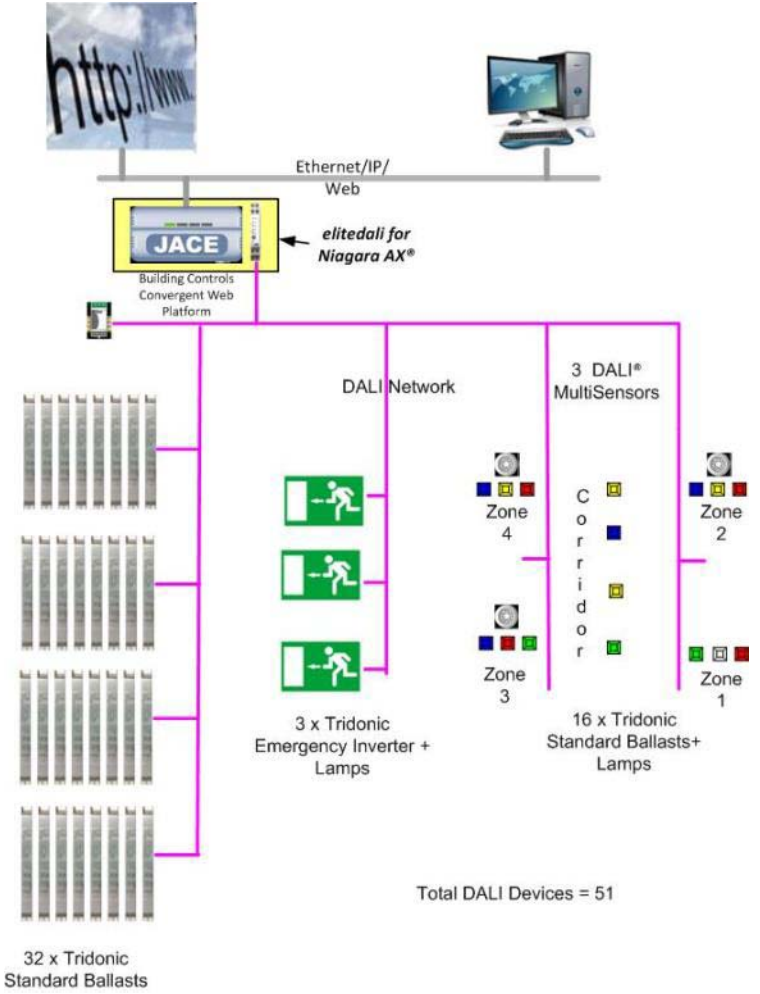

CNS-Enocean™ for Niagara AX



Web based Niagara AX® solution for EnOcean wireless switches and sensors -

- ◆ Commissioning
- ◆ Control
- ◆ Maintenance
- ◆ Management
- ◆ Visualisation
- ◆ Analytics

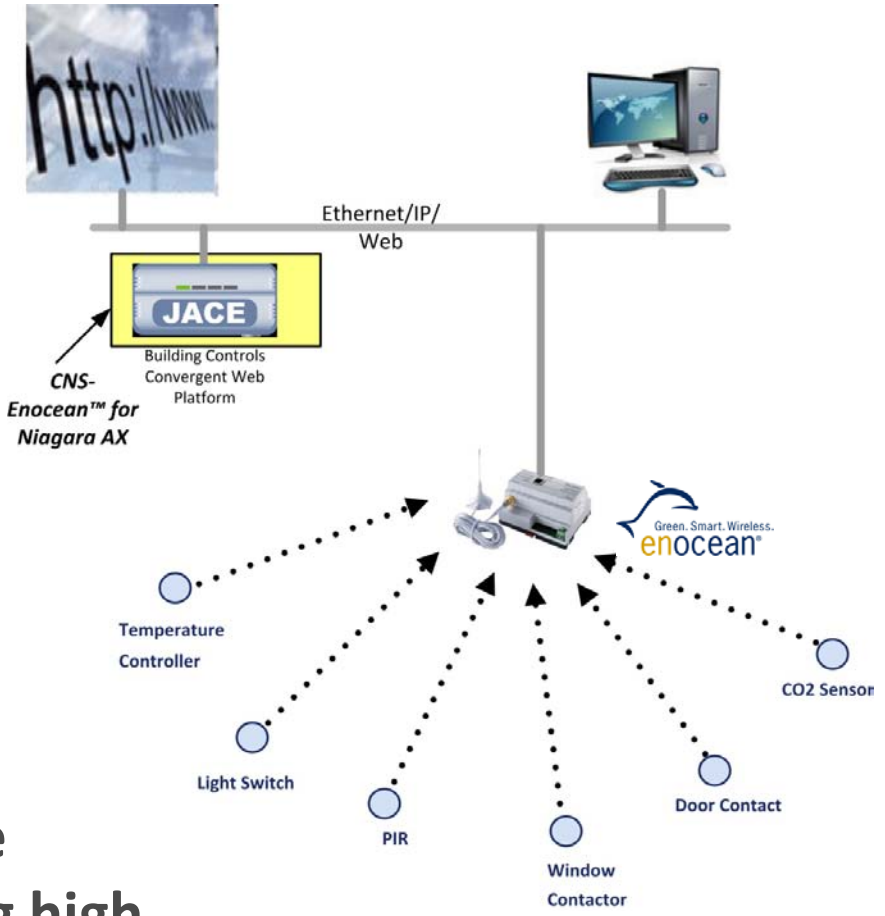

Delivered by organizations whose business depends upon delivering high quality solutions and levels of service.

CNS elitedali + EnOcean

CNS-ENOCEAN for Niagara AX
Wireless. Batteryless. Ethernet

Web commission, control and manage DALI™ within Niagara AX™

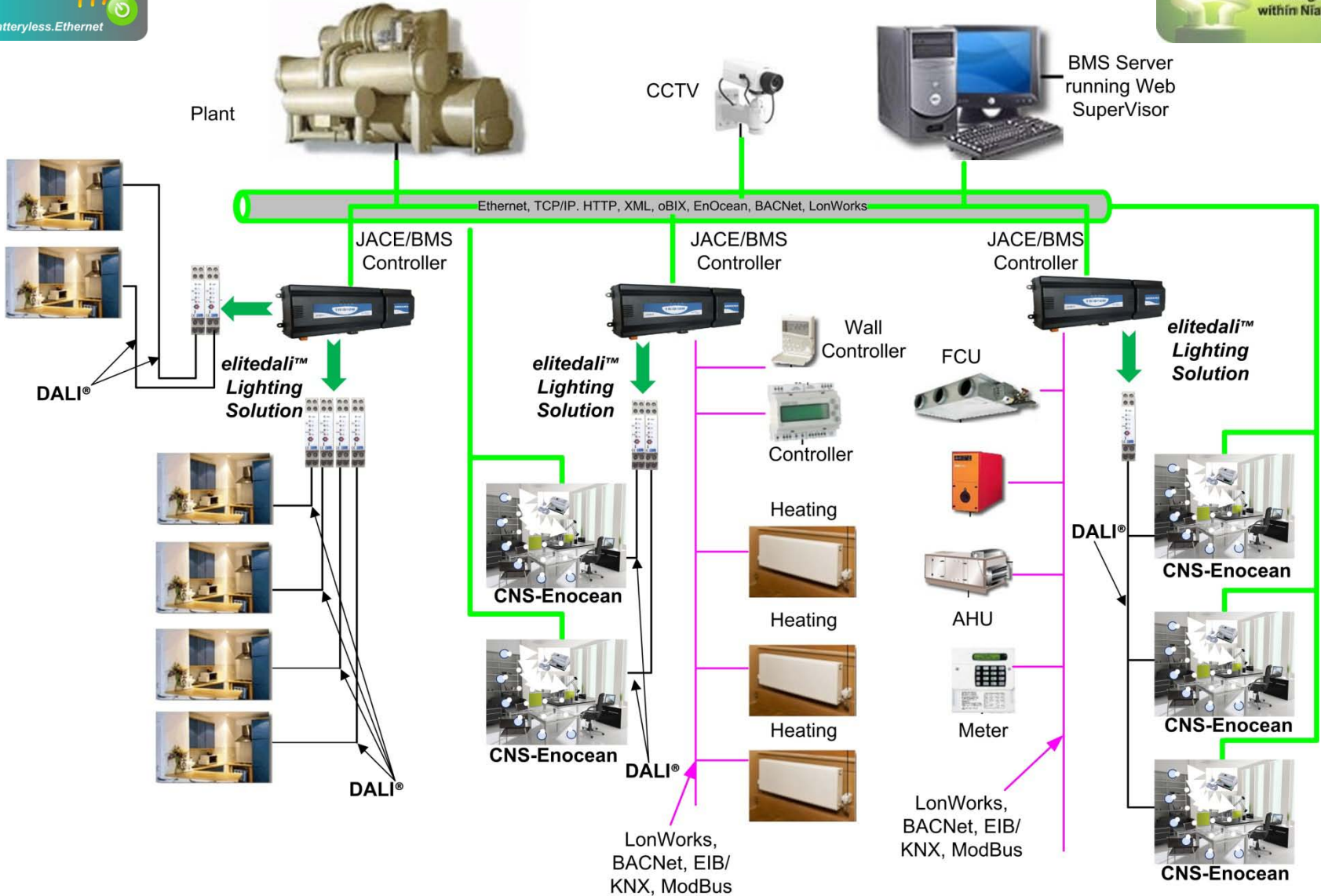

Contact Details

 **Control Network Solutions Ltd, Studio 7, Intec 2, Intec Business Park, Wade Road, Basingstoke, Hampshire, RG24 8NE, England**

 **Tel:** +44(0) 1256 818700

 **Fax:** +44(0) 1256 812520

 **Email:** sales@control-network-solutions.co.uk

 **Web:** www.control-network-solutions.co.uk

 **Web:** www.cns-enocean.com

 **Twitter:** twitter.com/enocean4ax

 **LinkedIn:** [CNS-Enocean for Niagara AX](#)

 **Web:** www.elitedali.com

 **Twitter:** twitter.com/elitedali

 **LinkedIn:** [elitedali for Niagara AX](#)

DALI is the registered trademark of DALI-ag, Niagara AX and JACE are registered trademarks of Tridium Inc., *elitedali*, *eDIM*, *CeP* and *eLighting* are the trademarks of Control Network Solutions Ltd's Niagara AX intelligent lighting products and solutions., CNS-Enocean is the trademark of Control Network Solutions Ltd's Niagara AX intelligent EnOcean products and solutions, EnOcean is the registered trademark of EnOcean GmbH, EnOcean Alliance is the trademark of the EnOcean Alliance group.